

Citihoop Rax 3-Bay

Top View

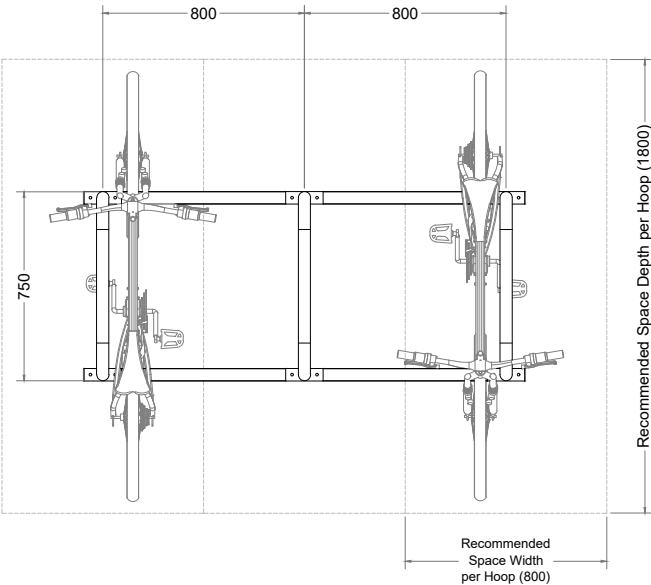

Perspective View



Front View

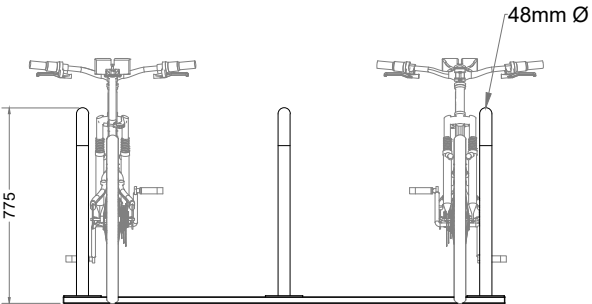

Side View

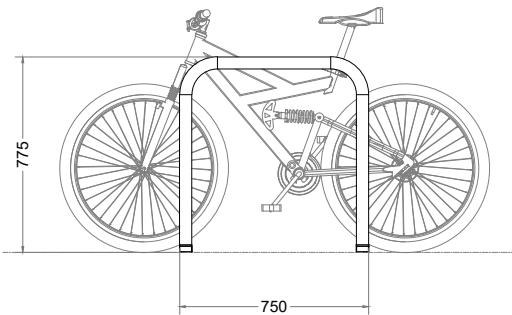

Technical information

- Materials:** Mild Steel
- Standard Finish:** Galvanised to BS EN ISO 1461:2009
- Optional Finishes:** Powder-coating in any standard RAL colour
Stainless Steel Grade 304 or 316
- Bike Capacity:** 6No. (2No. Bikes per hoop)
- Fixing:** Surface Mounted with base rails
- Optional Extras:** Location identifiers, signage
- BREEAM:** Our products will assist with achieving BREEAM rating
- Product Warranty:** Two years
- Benefits:** Citihoop Rax combines the simple and effective hoop profile with channel tracks ensuring the hoops are spaced equally, in a straight line, and making for a quicker and easier installation.



Manufactured in the UK

PRODUCT NAME:

Citihoop Rax 3-Bay

SCALE: 1:30	SHEET SIZE: A3	DRAWN BY: AA
CHECKED BY: KD	DATE: 03/08/2022	
PRODUCT NO. :		SS-TRS

- All dimensions are in mm unless otherwise stated
- Any dimensions scaled from this drawing are taken at the reader's own risk



01730 719 292
info@bellsure.co.uk
bellsure.co.uk