

Single Decker Classic 375

Top View

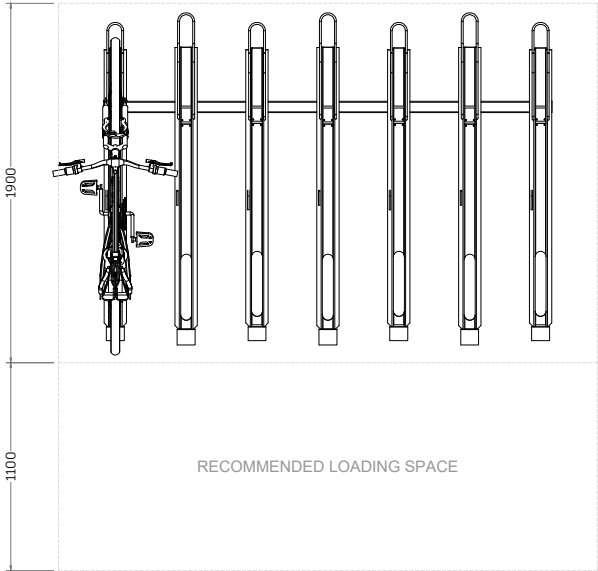

Perspective View



Front View

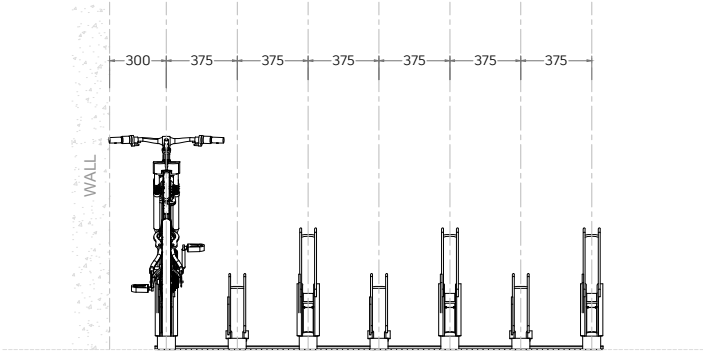

Right Side View

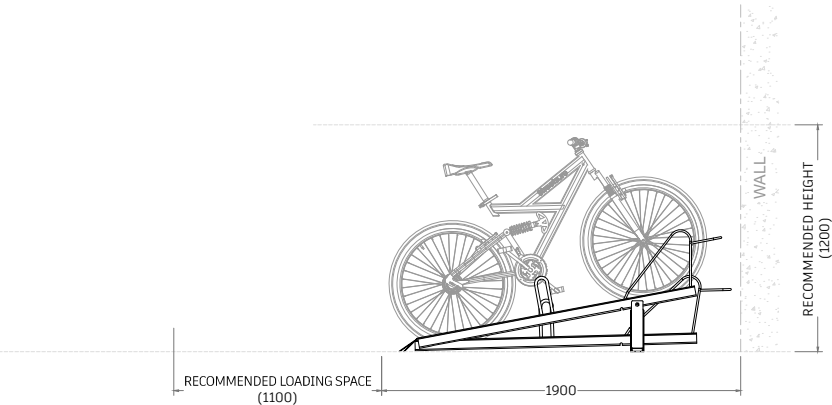

Technical information

- Materials:** Mild Steel
- Standard Finish:** Galvanised to BS EN ISO 1461:2009
- Optional Finishes:** Powder-coating in any standard RAL colour
- Configuration:** Single Sided
- Bike Capacity:** Bespoke to customer specification
- No. of Locking points:** 3No. per bike space
Front wheel, Middle locking loop & Rear Wheel
- Fixing Options:** Surface Mounted
- Optional Extras:** Location identifiers, anti-tamper fixings, signage
- BREEAM:** Our products will assist with achieving BREEAM rating
- Product Warranty:** Two years
- Recommended Height:** 1200mm
- Benefits:** This British made two-tier rack is built to last, it requires minimal maintenance and can be space planned to fit a variety of unique locations.

PRODUCT NAME:

Single Decker Classic 375

SCALE: 1:40	SHEET SIZE: A3	DRAWN BY: AA
CHECKED BY: KD	DATE: 01/07/2022	
PRODUCT NO. :		SDCL375

- All dimensions are in mm unless otherwise stated
- Any dimensions scaled from this drawing are taken at the reader's own risk



01730 719 292
info@bellsure.co.uk
bellsure.co.uk