



# TRANSFORMING THE WAY WE THINK ABOUT DOORS

Q-Mark® Fire Doorsets  
available from stock



## FLEXIBILITY IN 4D™

03300 557630 | [info@modulodoorsets.com](mailto:info@modulodoorsets.com) | [modulodoorsets.com](http://modulodoorsets.com)

# THE MODULO DOORSET. GET IT RIGHT, FIRST TIME.

What makes the Modulo doorset different?



REQUEST A QUOTE ONLINE

### CONCEALED FIX SYSTEM

Innovative Rapd fit brackets, for ease of installation

### PRE-HUNG IN FRAME OPTION

Helping to overcome problems on-site, before they happen

### PRE-FITTED IRONMONGERY

All non-protruding components factory fitted for safe transportation

### PRE-MITRED ARCHITRAVE

No cutting required on site

### ADAPTABLE FRAME

Giving you flexibility and tolerance in four dimensions

### SIMPLE INSTALLATION

Compared to a conventional doorset

# LEADING THE WAY WITH INNOVATIVE SOLUTIONS

Why were Modulo Doorsets created?

REQUEST A FRAME SAMPLE PACK

We all know that fire doorset lead times have become a problem... But not everyone knows that the Modulo range from Bellsure has been created to address this issue by applying 'IKEA®' principles to the supply process without in any way compromising compliance.

Historically, doors and linings were a bespoke item modified on site to suit the opening where they were fitted.

Things have moved on with the advances in offsite manufacture driven by the cost and shortage of skilled site labour, but the Modulo concept represents a quantum leap by making most of the common combinations of flush fire doors available 'off the shelf' at our specialist fast track production and distribution facility in the South West.

### There are two key elements to this unique offering:

The patented installation system allows up to 20mm of adjustment in each dimension ensuring perfectly-fitting doors in structural openings not perfectly formed.

By stocking fully machined doorframe components and door leaves (along with the relevant ironmongery), thousands of Q-Mark® certified doorset combinations can be picked, pre-hung, packed and dispatched within hours.

### Does this sound too good to be true?

By investing in innovative modular design and relevant certification, this range has been specifically created to fill a gap in the market where construction, passive fire protection and FM contractors need FD30 fire doorsets in a few days. The concept is truly transforming the way we think about doors.

A full range of complementary non-fire-rated doors is also available from stock. For large projects where the substantial installation cost savings are a further benefit, a greatly expanded selection of finishes and designs is available.



# FLEXIBILITY IN 4D™



1

FLEXIBILITY ON STRUCTURAL OPENING WIDTH 32MM

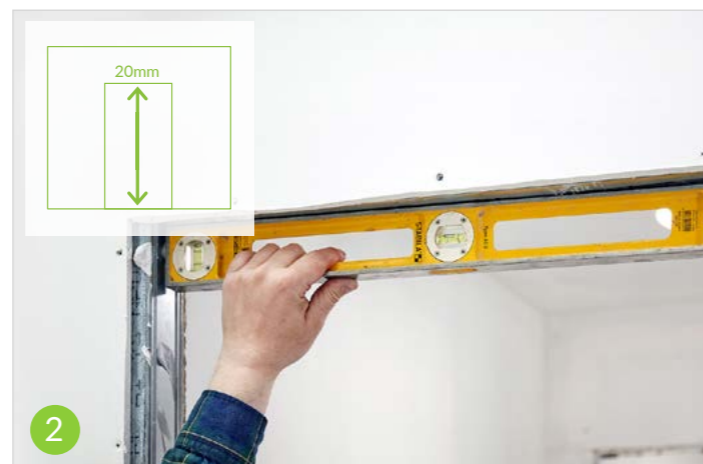

2

FLEXIBILITY ON STRUCTURAL OPENING HEIGHT 20MM



3

FLEXIBILITY ON WALL THICKNESS 27MM

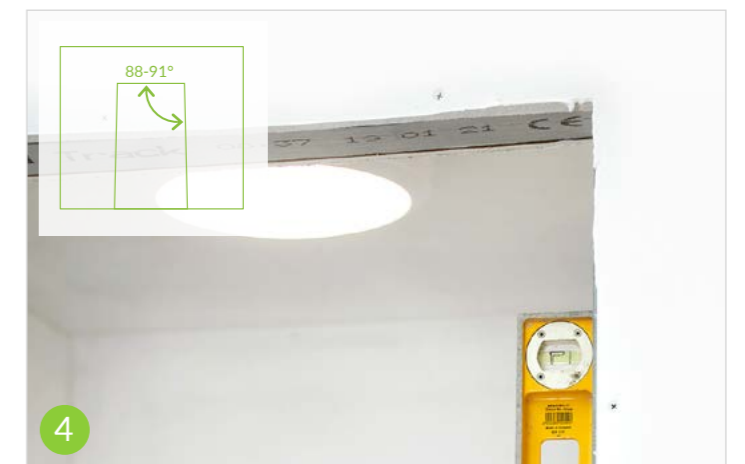

4

FLEXIBILITY ON HORIZONTAL & VERTICAL ANGLES 88-91°



OVER 1,000 DOORSET CONFIGURATIONS AVAILABLE 'OFF THE SHELF'



## FIRE DOORSETS IN STOCK

Bellsure have designed the **innovative and adaptable Modulo Doorset solution** to benefit all stakeholders in the construction industry, from architects through to installers.

### USE OUR ONLINE INSTANT DOORSET SELECTOR

modulodoorsets.com provides an easy-to-use tool for on-site doorset pricing

INSTANT DOORSET SELECTOR



- 1 Extensive stock of pre-machined components
- 2 The standards-based modular design ensures all configurable options are fully compliant
- 3 Standardised vision panels and ironmongery can be specified at time of order
- 4 Careful selection of colours, sizes and material specification along with our adaptable frame design means we can cover most fire doorset requirements from stock



#### QUICK TO SPECIFY

Suitable for a range of projects including **commercial, accommodation and refurbishment**. Simple to select and specify, reducing design and planning costs.



#### QUICK TO PRODUCE

Offsite manufacturing precision. **Minimal lead times** from order placement to delivery, providing the industry with world-class lead times.



#### QUICK TO PRICE

Our unique **instant doorset selector** makes door procurement extra simple. Value for money in our competitively priced doorsets and **strategic savings** across your project.



#### QUICK TO INSTALL

Modulo gives you the flexibility to adjust with its impressive structural opening tolerance. **Less time on site, no snagging or call backs.**



# DOORSET SPECIFICATION

Providing everything you need to specify a Modulo Doorset online

[VIEW TECHNICAL DOWNLOADS ONLINE](#)



## FINISHES

A variety of laminates and surfaces ready for coating.



- SANDED PLYWOOD**  
A smooth sanded plywood finish, ready to prime
- READY TO PAINT**  
A ready to paint white polymer finish
- OAK LAMINATE**  
Hardwearing, continuous pressure laminate (CPL), with a light oak textured finish
- GREY LAMINATE**  
Hardwearing, continuous pressure laminate (CPL), with a dark grey finish.
- WHITE LAMINATE**  
Hardwearing, continuous pressure laminate (CPL), with a white satin finish.

## CONFIGURATIONS

Modulo doorsets are provided in either single, equal double, or unequal double configurations to cover a range of standard doorset scenarios.



- SINGLE**  
Single internal timber doorset
- EQUAL DOUBLE**  
Double internal timber doorset
- UNEQUAL DOUBLE**  
Unequal double internal doorset, often referred to as 'leaf and a half'

## VISION PANELS

Non-Fire rated and FD30 options, provided in different styles dependent upon the door application selected. Hardwood bolection beading provided as standard.

*\*Clear sight dimensions indicated*



- TYPE 1**  
170mm x 745mm glass
- TYPE 2**  
Part M Compliant, 170mm x 1470mm glass



[REQUEST A FRAME SAMPLE PACK](#)

## THE MODULO DOOR FRAME SYSTEM

Three Modulo doorset frame depths to suit most structural openings.

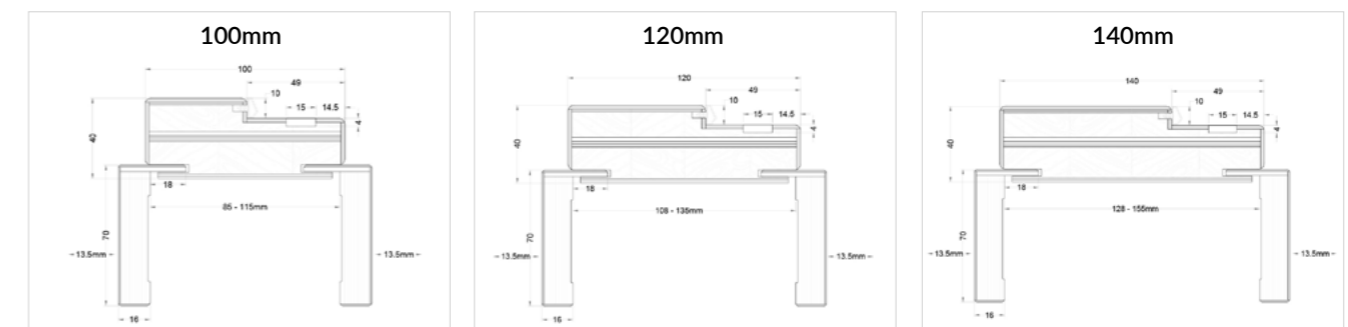

- 100mm**  
To suit wall thicknesses from: 88-115mm
- 120mm**  
To suit wall thicknesses from: 108-135mm
- 140mm**  
To suit wall thicknesses from: 128-155mm

## DOORSET SPECIFICATION

Providing everything you need to specify a Modulo Doorset online



VISIT OUR SHOWROOM



Our knowledgeable and super-helpful team are always on hand to discuss your requirements – please get in touch!  
Call us today: 03300 557630

REQUEST A QUOTE ONLINE



### METRIC DOOR LEAF SIZES

LEAF WIDTH (mm)	326	426	526	626	726	826	926
LEAF HEIGHT (mm)	2040	2040	2040	2040	2040	2040	2040

### IMPERIAL DOOR LEAF SIZES

LEAF WIDTH (mm)	457	533	762	838	914
LEAF HEIGHT (mm)	1981	1981	1981	1981	1981

### STRUCTURAL OPENING MATRIX

#### METRIC DOORSETS

	Door Leaf Size	Over frame width	Over frame height*	Min. structural opening width	Optimum structural opening width	Max. structural opening width	Min. structural opening height*	Optimum structural opening height*	Max structural opening height*
SINGLE	626 x 2040	692	2080	700	710	732	2083	2100	2105
	726 x 2040	792	2080	800	810	832	2083	2100	2105
	826 x 2040	892	2080	900	910	932	2083	2100	2105
	926 x 2040	992	2080	1000	1010	1032	2083	2100	2105
EQUAL PAIR	526 + 526 x 2040	1122	2080	1130	1140	1162	2083	2100	2105
	626 + 626 x 2040	1322	2080	1330	1340	1362	2083	2100	2105
	726 + 726 x 2040	1522	2080	1530	1540	1562	2083	2100	2105
	826 + 826 x 2040	1722	2080	1730	1740	1762	2083	2100	2105
	926 + 926 x 2040	1922	2080	1930	1940	1962	2083	2100	2105
UNEQUAL PAIR	426 + 726 x 2040	1122	2080	1130	1140	1162	2083	2100	2105
	526 + 726 x 2040	1222	2080	1230	1240	1262	2083	2100	2105
	426 + 826 x 2040	1322	2080	1330	1340	1362	2083	2100	2105
	426 + 926 x 2040	1422	2080	1430	1440	1462	2083	2100	2105
	526 + 926 x 2040	1522	2080	1530	1540	1562	2083	2100	2105

### STRUCTURAL OPENING MATRIX

#### IMPERIAL DOORSETS

	Door Leaf Size	Over frame width	Over frame height*	Min. structural opening width	Optimum structural opening width	Max. structural opening width	Min. structural opening height*	Optimum structural opening height*	Max structural opening height*
SINGLE	762 x 1981	828	2031	836	848	868	2035	2043	2051
	838 x 1981	904	2031	912	924	944	2035	2043	2051
	914 x 1981	980	2031	988	1000	1020	2035	2043	2051
EQUAL PAIR	762 + 762 x 1981	1594	2031	1602	1618	1634	2035	2043	2051
	838 + 838 x 1981	1746	2031	1754	1770	1786	2035	2043	2051
	914 + 914 x 1981	1898	2031	1906	1922	1938	2035	2043	2051
UNEQUAL PAIR	762 + 457 x 1981	1289	2031	1297	1313	1329	2035	2043	2051
	838 + 457 x 1981	1365	2031	1373	1389	1405	2035	2043	2051
	914 + 457 x 1981	1441	2031	1449	1465	1481	2035	2043	2051
	914 + 533 x 1981	1517	2031	1525	1541	1557	2035	2043	2051

\* Standard factory undercut is 17mm unless otherwise specified. Minimum undercut is 3mm. Structural opening height will vary accordingly. Jamb's can be trimmed at time of installation as required.



# IRONMONGERY

Unique. Innovative. Adaptable.

## HANDLES

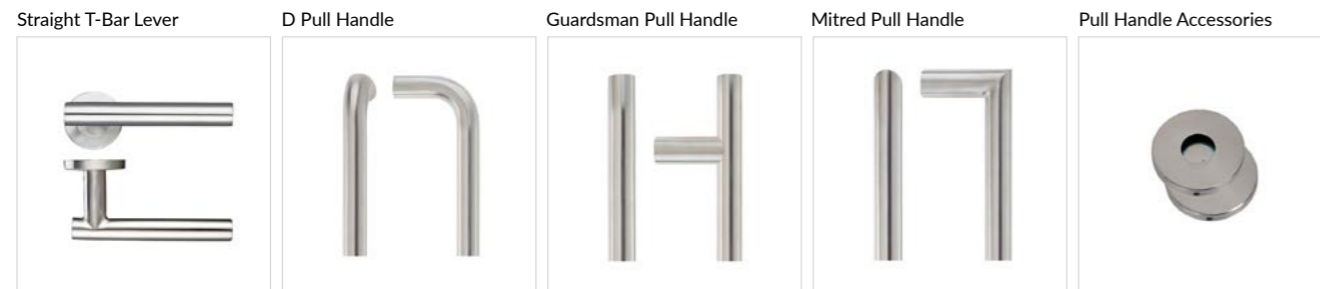

## DOOR CLOSERS



## LOCKS & LATCHES



## CYLINDERS

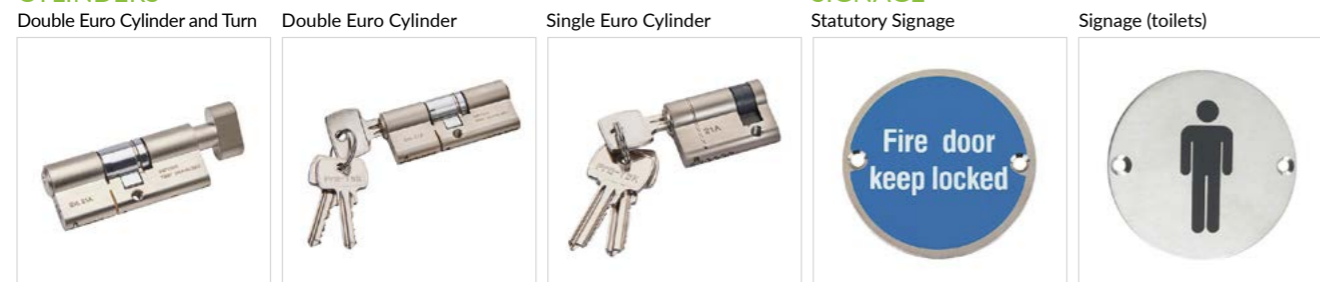

Our knowledgeable and super-helpful team are always on hand to discuss your requirements – please get in touch!

Call us today: 03300 557630

[DOWNLOAD SPECIFICATION SHEETS](#)

## INTUMESCENTS & SEALS



## ANCILLARY

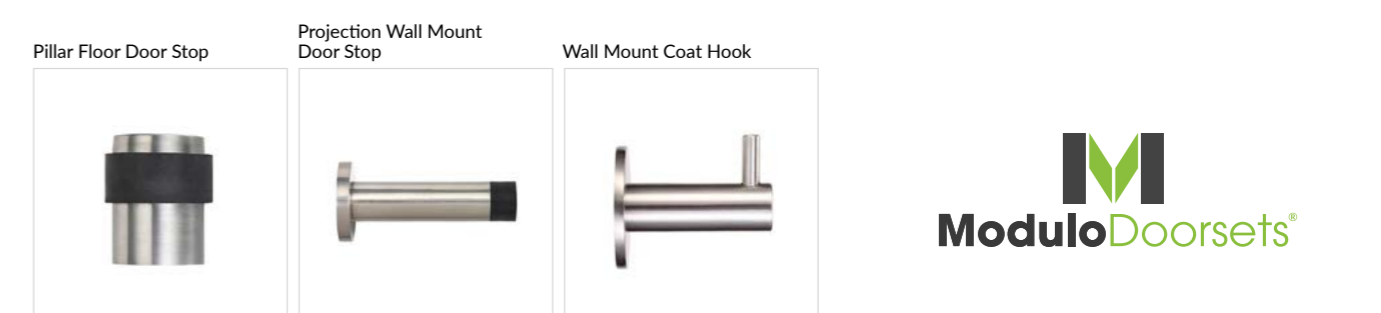



Our knowledgeable and super-helpful team are always on hand to discuss your requirements – please get in touch!

Call us today: 03300 557630

[VISIT OUR WEBSITE](#)

## CERTIFICATION & ACCREDITATIONS

Providing everything you need to specify a Modulo Doorset

Modulo Q-Mark® doorsets are fully accredited and up to date with all the latest compliance standards, download all of the documentation you need below.

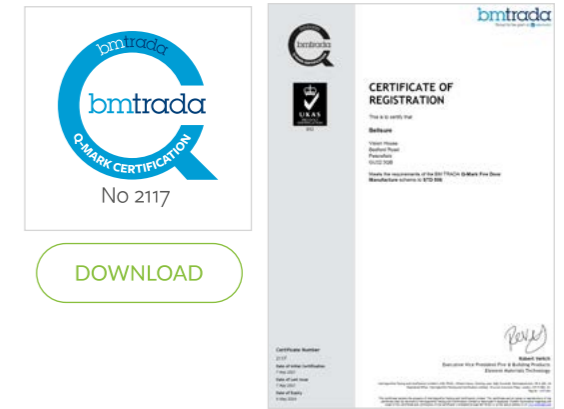

[DOWNLOAD](#)

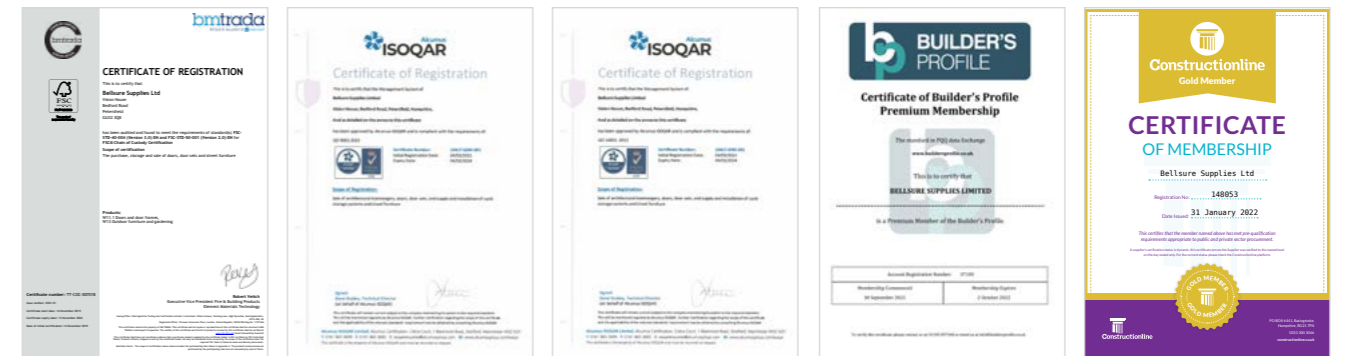

[FSC  
DOWNLOAD](#)

[ISO 9001  
DOWNLOAD](#)

[ISO 14001  
DOWNLOAD](#)

[BUILDER'S PROFILE  
DOWNLOAD](#)

[CONSTRUCTIONLINE GOLD  
DOWNLOAD](#)



[RISQS  
DOWNLOAD](#)

[SMAS WORKSAFE  
DOWNLOAD](#)

[CHAS  
DOWNLOAD](#)

[SAFECONTRACTOR  
DOWNLOAD](#)

[CQMS  
DOWNLOAD](#)

[REQUEST A QUOTE ONLINE](#)

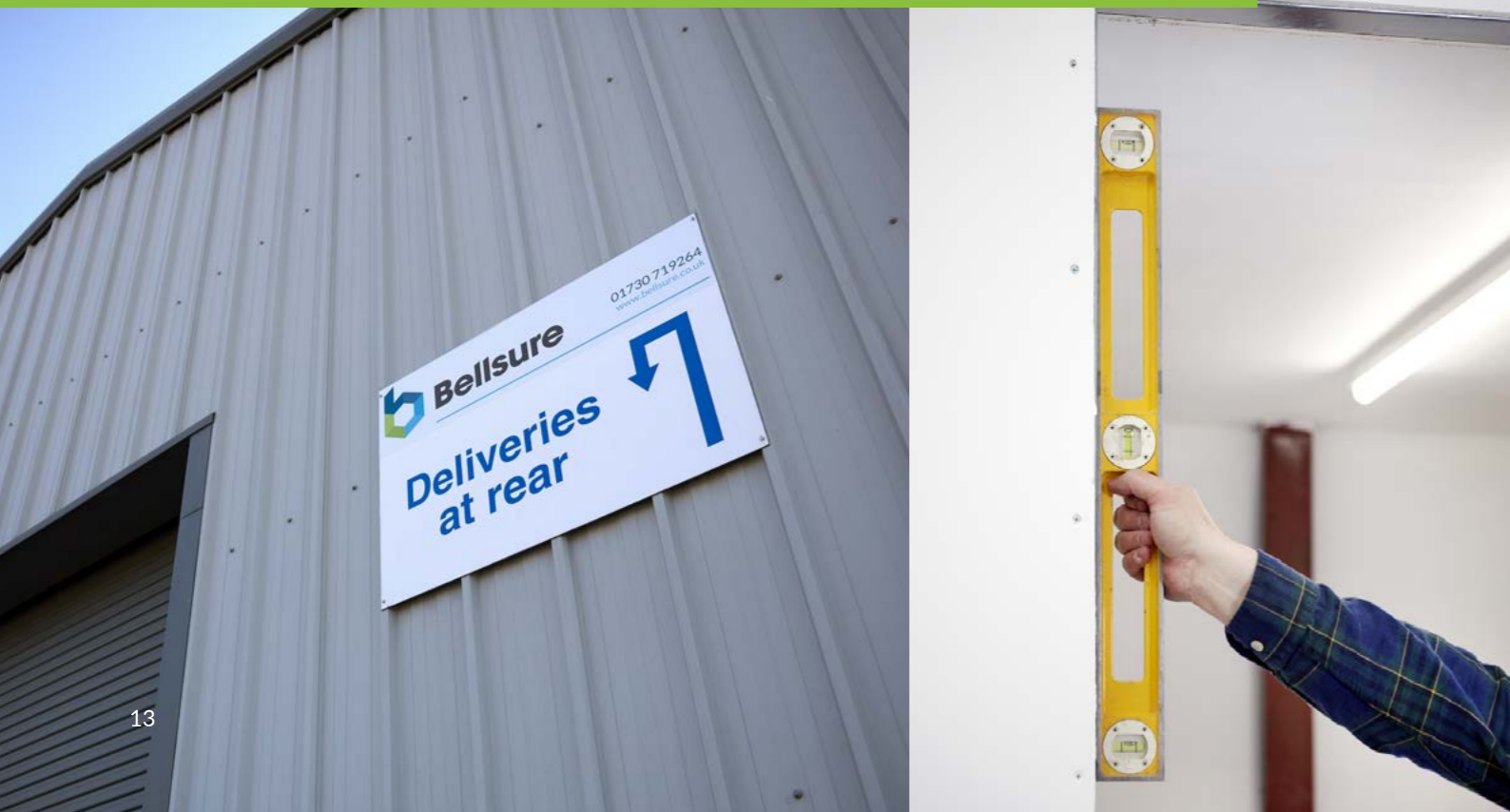



# CONFIGURABLE DOORSETS FOR PROJECTS

Unique. Innovative. Adaptable.

Our pre-hung Q-Mark® Fire Doorsets available from stock are perfect for quick turn around projects, however Modulo Doorsets are also extremely effective on large scale new-build and refurbishment projects.

Configuring doorsets for large projects has never been easier...



## WHAT ARE THE ONGOING BENEFITS TO OUR CUSTOMERS?

Speed of installation greatly de-risks program delays

**Pre-mitred** architraves, no mitre cuts on site

**Adjustable** lining and architrave

Only a **basic skill set** required for easy installation

[FIND OUT MORE HERE](#)

# KEY COMPONENTS

Everything you need to configure a Modulo doorset

DOORSET SPECIFICATION



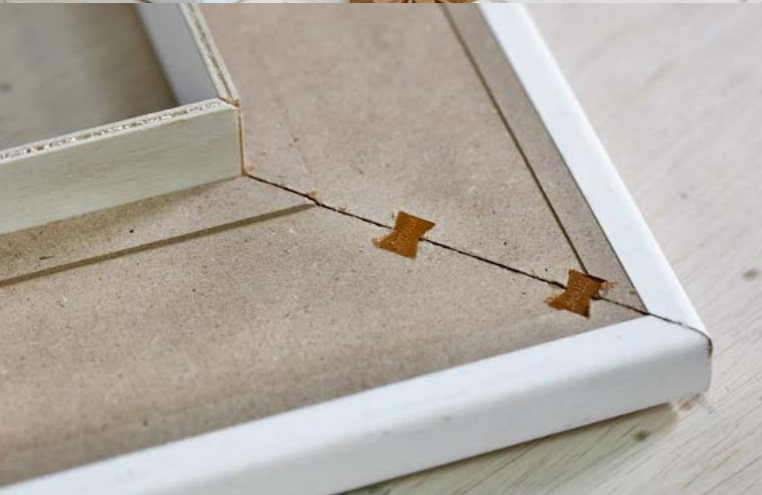

## GET IN TOUCH

Get in touch to discuss your next project or see Modulo Doorsets in action at our brand new showroom.

Call us: 03300 557630

Thousands of Q-Mark certified doorset combinations picked, pre-hung, packed and dispatched within hours.

### COLLECTION & DELIVERY

Collection and delivery from our production facilities at:

46 Buckland Rd, Pen Mill Trading Estate, Yeovil BA21 5EL  
Trinity House, 111 River Rd, Barking IG11 0EX

All prices subject to V.A.T.

### LEAD TIMES

Standard lead times are 7-10 days.

There is an express service available.

[VISIT OUR WEBSITE](#)

[EMAIL US HERE](#)

[REQUEST A FRAME SAMPLE KIT](#)

[REQUEST A QUOTE ONLINE](#)





**ModuloDoorsets**<sup>®</sup>

TRANSFORMING  
THE WAY WE THINK  
ABOUT DOORS

**ModuloDoorsets**<sup>®</sup>

01730 719 292 | info@modulodoorsets.com

modulodoorsets.com

## GET IN TOUCH

Our team are always on hand to discuss your requirements - please get in touch!

03300 557630

[info@modulodoorsets.com](mailto:info@modulodoorsets.com)

[modulodoorsets.com](http://modulodoorsets.com)



**Bellsure**

[www.bellsure.co.uk](http://www.bellsure.co.uk)